

# AVerDiGi EB1504NET DVD/1504 NET

4 Channel Network Video Recorder

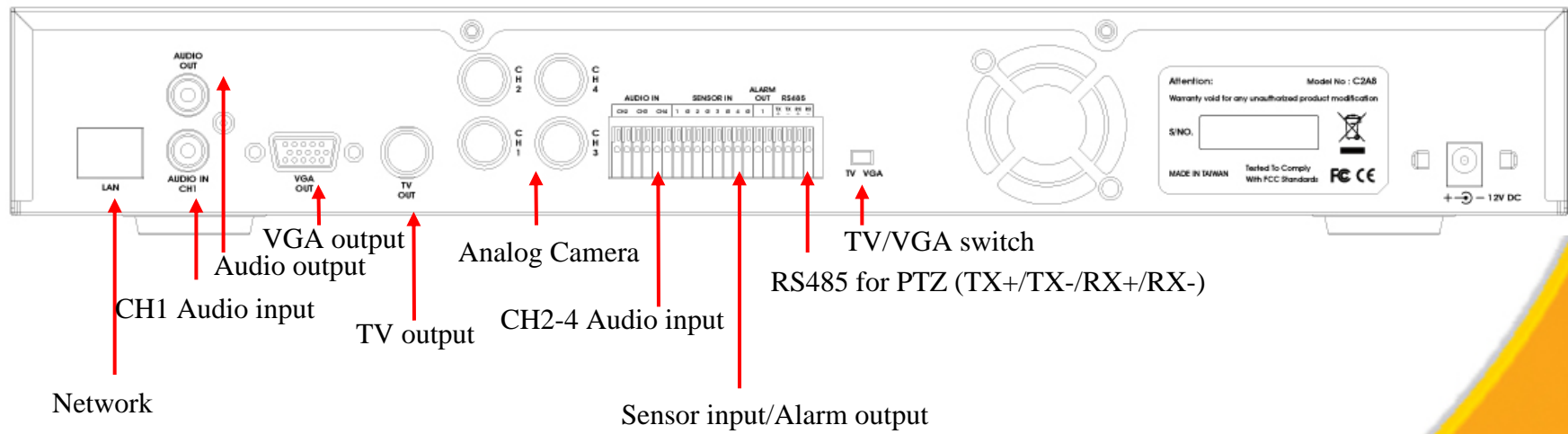

# Front & Rear View (EB1504NET DVD)

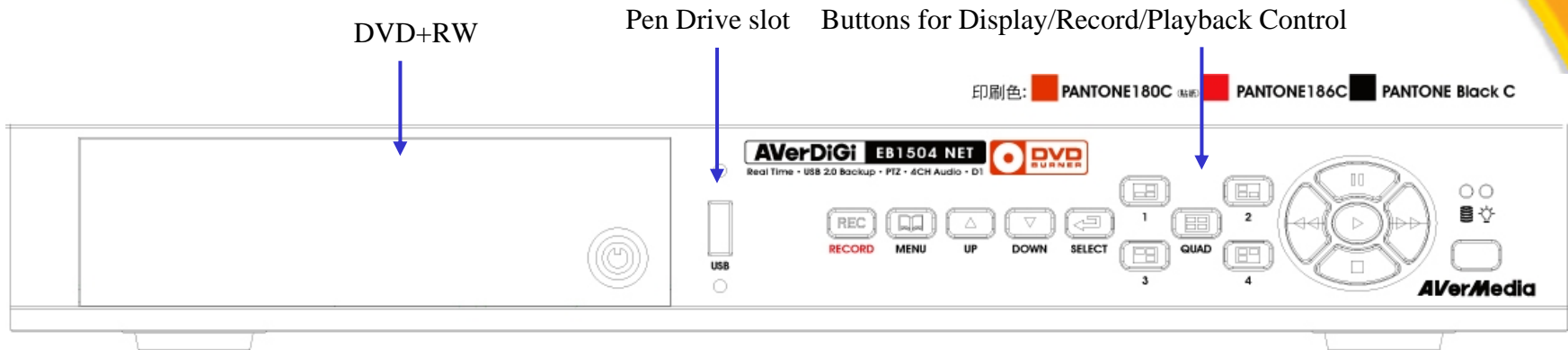

# Front & Rear View (EB1504 NET)

Removable HDD bay

Pen Drive slot

Buttons for Display/Record/Playback Control

印刷色: ■ PANTONE186C ■ PANTONE Black C

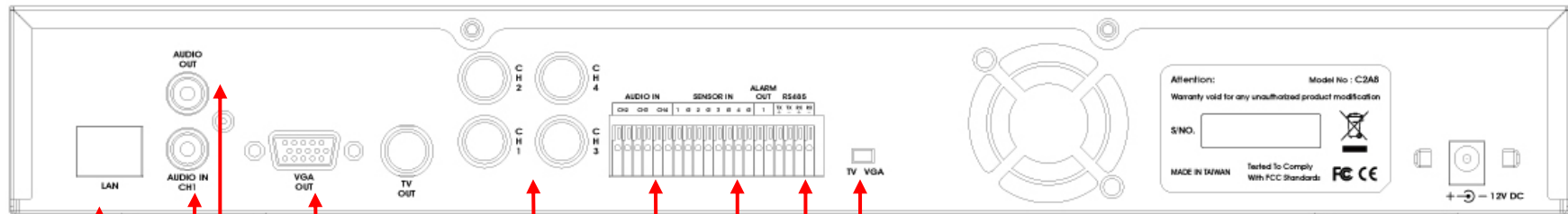
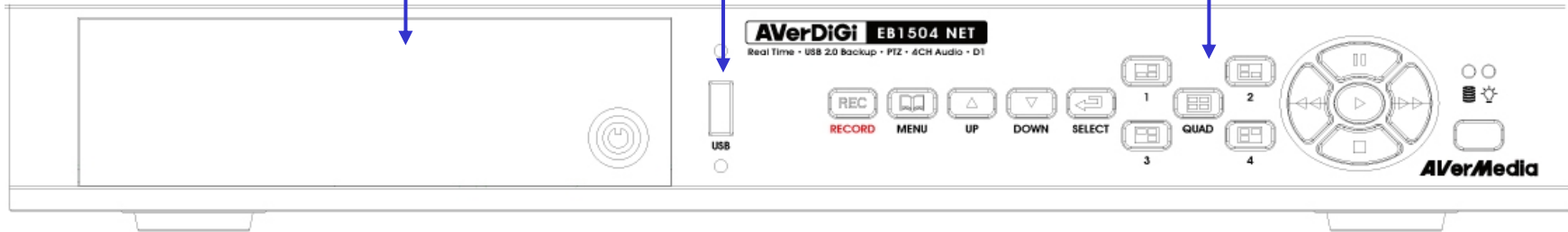

LAN

CH1 Audio input

Audio output

VGA output

TV output

Analog Camera

CH2-4 Audio input

Sensor input/Alarm output

RS485 for PTZ (TX+/TX-/RX+/RX-)

TV/VGA switch

12V DC

# Unique Selling Point

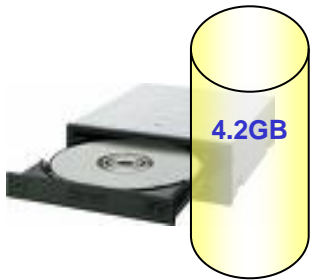

Backup to DVD+RW  
or Pen Drive



Mobile phone Viewer  
(JavaViewer)



Preview and  
playback on PDA



Multiplex



Central Monitor System



PTZ supported



Four Audio Inputs



Auto Time Correction  
via Internet

# PTZ camera

---

- Support 4 channel PTZ cameras
- Support Pelco-D and Pelco-P protocol. Other protocols are supported by request



# DVD+RW/Pen Drive

- Easy to archive the video clips via DVD+RW/Pen Drive
- Support upgrade system via Pen Drive
- Built-in video file player- User only need to bring DVD or pen drive without any other software to police office



# Enhanced Pen Drive Function

## ■ Multi-channels playback

Play multiple channels  
from Pen Drive synchronously

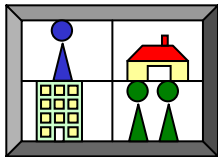

**EB1504NET DVD/EB1504 NET-**

**Very convenience for user to check  
several related places in the same screen.**

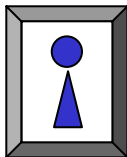

**Other companies' products –  
Not easy for Users to check the related  
places in one screen.**

## ■ Built-in player

Built-in player to playback video without  
carrying additional CD to install on PC.



**EB1504NET DVD/EB1504 NET-**

**Built-in player. Save time when  
emergency.**



**Other companies' products –  
Users have to spend time to find out and  
carry the installation CD to the police  
office when emergency.**

# Enhanced DVD+RW Function

## ■ Multi-channels playback

Play multiple channels  
from DVD synchronously

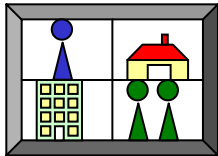

## ■ Built-in player

Built-in player to playback video without  
carrying additional CD to install on PC.

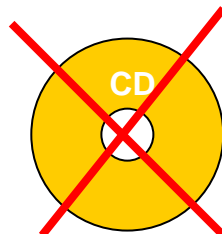

## ■ Large backup size on DVD

Larger backup size and rewritable  
DVD+RW to save users' money and time.

EB1504NET DVD

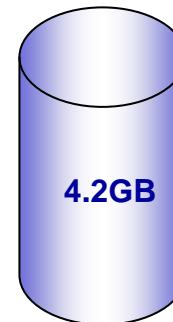

DVD RW

Other companies' products



CD RW



# Mobile Phone Viewer

- Easy to preview video on mobile phone with Java viewer



# PDA Viewer

- Easy to get 4CH MPEG4 video
- Live display video with audio
- Playback video from EB1504NET DVD/1504NET



# Sending Photo by Sensor/Motion Triggered

- When motion be triggered, system will sending mail with the trigger time photo and message
- When sensor be triggered, system will sending mail with the trigger time photo and message

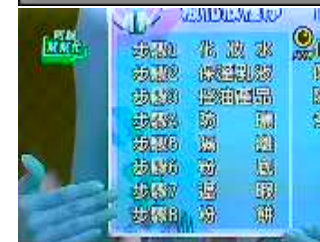
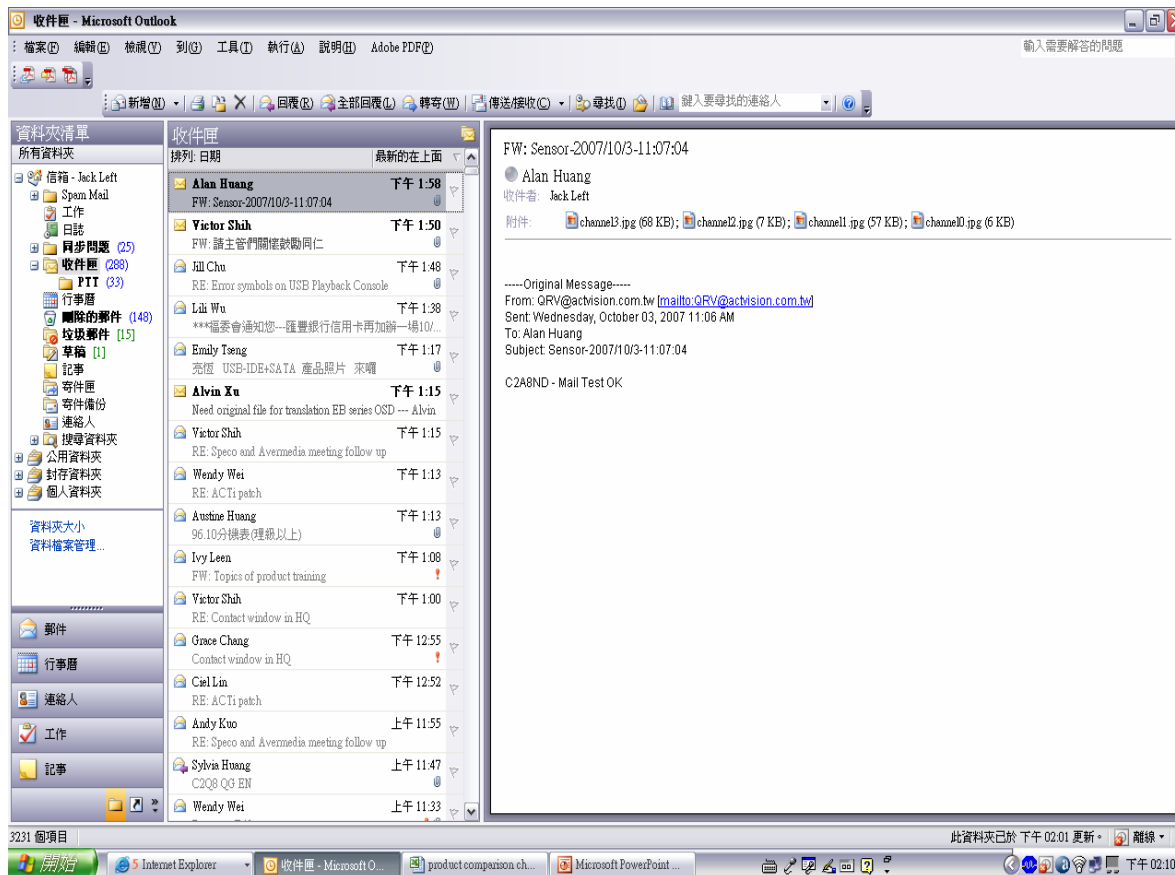

# Upgrade System via internet or pen drive

- **Easy for installer to upgrade the DVR system for end customer via Internet**
  - **Save your time and money to upgrade the DVR system via Internet.**
  - **You could also upgrade system from pen drive**



Easy and convenient

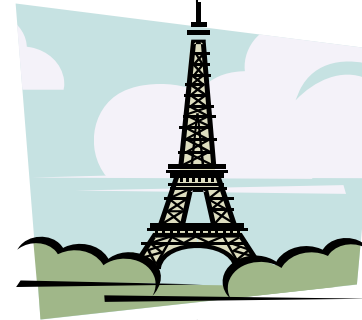
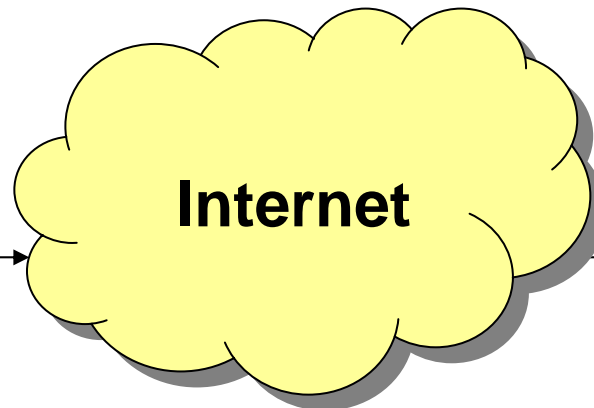

# Auto Time Correction & Day Light Saving

---

- Support 2 NTP servers (User defined server will be supported later).
- System will correct DVR time from network automatically
- Daily time adjustment to avoid system time delay
- Day Light Saving setting



# Central Monitoring System

## ■ CM3000: a powerful central monitoring system

- Enables to monitor up to 1024 DVR servers via internet.
- Connect to AVerDiGi EB and NV Series DVR
- Automatically records and displays video when an event has occurred on the remote side of DVR server.
- Playback video files locally or download from a remote DVR server .
- Supports up to four monitor displays



# iEnhance

- iEnhance video processing software for better video quality.
- iStable to avoid shaking impact (ex: the shaking from PTZ camera) on video



# AVerDiGi EB1504NET DVD/1504 NET Feature

- Support 4 Channel Audio Record
- Support PTZ Control
- Support DVD+RW backup (for EB1504NET DVD)
- Support Removable HDD bay (for EB1504 NET)
- Support remote preview on mobile phone (with JavaViewer)
- Remote preview and playback on PDAViewer
- Support Day Light Saving Setting
- Support Auto Correct Time Setting
- MPEG-4 compression
- Multiple clients and dynamic IP supported
- One HDD for recording
- Motion detection recoding
- Support Central Monitor System
- Support audio recording via internet
- Synchronized video and audio
- Support Pen drive backup
- Display on TV or VGA.
- Real Time display - 120 fps
- Real Time play back - up to 120 fps (CIF mode) / 60 fps (D1 mode)
- On Screen Display with multi-lingual
- Easy to use with remote control
- Multiplex solution
- HDD bad sector skip mechanism